

LEGEND^{NX}

LGNXT04KIRWTF

4K TURRET HDTVI CAMERA WITH FIXED LENS



- 8MP High-Resolution Imaging
- 2.8mm fixed lens
- Up to 30m for IR Distance
- 120 dB True WDR and 3D DNR for better image clarity
- Supports: TVI, AHD, CVI, CVBS
- Water and dust resistant (IP67)



In short

This camera delivers 8MP Ultra HD resolution with a 2.8mm fixed lens, offering clear visuals and wide coverage. It features up to 30 meters of infrared night vision, 120 dB True WDR and 3D DNR for enhanced image quality, and is IP67-rated for water and dust resistance.

Dimensions

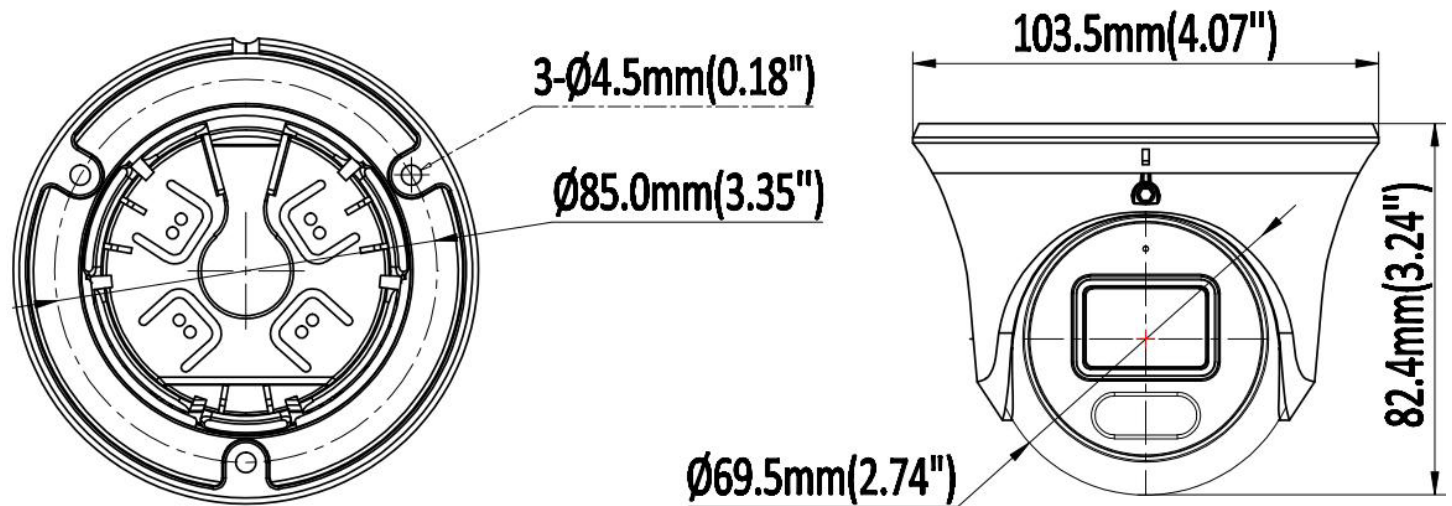

*Design and specifications are subjects to change without notice.

Technical Specifications

Camera: LGNXT04KIRWTF	
Image Sensor	1/2.8" CMOS Sensor
Signal System	PAL/NTSC
Effective Pixels	3840 (H) x 2160 (V)
Electronic Shutter	AUTO / 1/50 (1/60) ~ 1/50,000sec
Minimum Illumination	0.01Lux at (F1.2, AGC ON) , 0 LUX with IR
Video Frame Rate	PAL/NTSC: 8MP at 15fps
Video Output	AHD / TVI / CVI / CVBS
Camera Features	
S/N Ratio	≥ 50dB
Noise Reduction	3D DNR
Day/Night	EXT / Auto / Color / B & W
White Balance	ATW
Wide Dynamic Range	120 dB True WDR
IR LED	2
IR Range	30m / 98.43ft
Lens	
Focal Length	2.8 mm fixed lens
Field of View	2.8 mm : Horizontal FOV: 109°, Vertical FOV: 63°, Diagonal FOV: 125°
Lens Type	Fixed Iris
Thread Mount	M12
General	
Working Conditions	-40°C ~ +60°C, RH 95% MAX
Power Supply	DC12V (±10%)
Power Consumption	Less than 5W
Protection Level	IP67
Material	Metal
Dimensions	Φ 103.5 x 82.4 mm (Φ 4.07" x 3.24")
Weight	0.77 lb / 350g

*Design and specifications are subjects to change without notice.

What you may need



XLGNXLB10
Junction Box
Φ112.5 mm × 49.5mm



XLGNXPM03
Pole Mount
Φ170mm × 135.8mm × 43.7mm



XLGNXLB14C
Wall Mount
Φ120mm × 105.8mm x 183.5mm



XLGNXCM700
Pendent Mount Bracket
Φ116 mm × 734.5 mm

Accessories Mount

XLGNXLB10

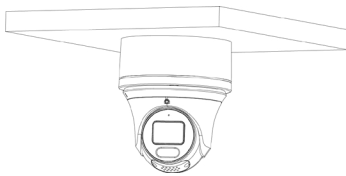

XLGNXLB14C

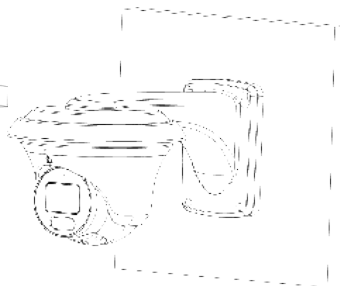

**XLGNXLB10 +
XLGNXLB14C**

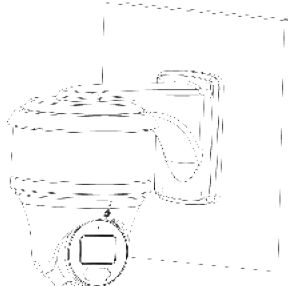

**XLGNXLB10 +
XLGNXCM700**

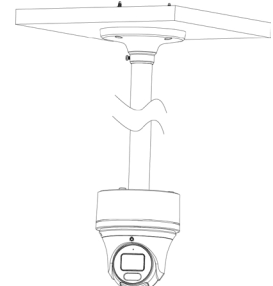

XLGNXPM03

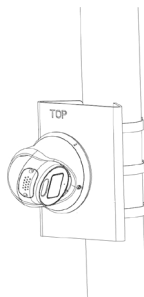

**XLGNXPM03 +
XLGNXLB10**

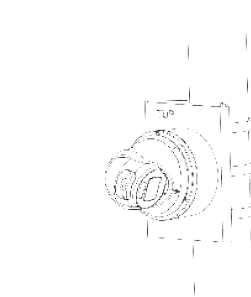

**XLGNXPM03 +
XLGNXLB14C**

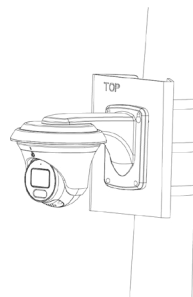

**XLGNXPM03 + XLGNXLB10 +
XLGNXLB14C**

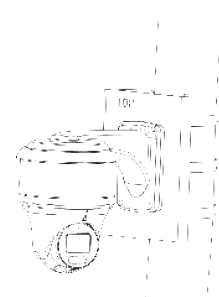

*Design and specifications are subjects to change without notice.